

## 4-2 高速整流ダイオード

### ●リード挿入

V <sub>RM</sub> (V)	I <sub>F</sub> (AV) (A) ( )フィン付	パッケージ Axial (ボディ径/リード径)	品名	I <sub>FSM</sub> (A) 50Hz 正弦半波単発	T <sub>j</sub> (°C)	T <sub>stg</sub> (°C)	V <sub>F</sub> (V) max	I <sub>F</sub> (A)	I <sub>R</sub> (μA)	I <sub>R</sub> (H) (μA)	T <sub>j</sub> (°C)	trr① (μs)	I <sub>F</sub> /I <sub>RP</sub> (mA)	trr② (μs)	I <sub>F</sub> /I <sub>RP</sub> (mA)	R <sub>th</sub> (j-l) R <sub>th</sub> (j-c) (°C/W)	質量 (g)
									V <sub>R</sub> =V <sub>RM</sub> max	V <sub>R</sub> =V <sub>RM</sub> max							
200	0.5	Axial (φ2.7/φ0.6)	EU01Z	15	-40~+150	1.0	0.5	10	150	100(Ta)	0.4	10/10	0.18	10/20	20	0.2	
	0.5	Axial (φ2.7/φ0.78)	EU 1Z	15	-40~+150	1.0	0.5	10	150	100(Ta)	0.4	10/10	0.18	10/20	17	0.3	
	0.5	Axial (φ2.4/φ0.6)	AU01Z	15	-40~+150	1.7	0.5	10	150	100(Ta)	0.4	10/10	0.18	10/20	22	0.13	
	0.6	Axial (φ4.0/φ0.78)	RH 1Z	35	-40~+150	1.3	0.6	5.0	70	150(Ta)	4.0	10/10	1.3	10/20	15	0.4	
	0.7	Axial (φ2.7/φ0.78)	ES 1Z	30	-40~+150	2.5	0.8	10	200	100(Ta)	1.5	10/10	0.6	10/20	17	0.3	
	0.8	Axial (φ2.4/φ0.6)	AU02Z	25	-40~+150	1.3	0.8	10	250	100	0.4	10/10	0.18	10/20	22	0.13	
	1.0	Axial (φ2.7/φ0.6)	EU02Z	15	-40~+150	1.4	1.0	10	300	100	0.4	10/10	0.18	10/20	20	0.2	
	1.0	Axial (φ2.7/φ0.78)	EU 2Z	15	-40~+150	1.4	1.0	10	3000	150	0.4	10/10	0.18	10/20	17	0.3	
	1.0	Axial (φ4.0/φ0.78)	RU 2Z	20	-40~+150	1.5	1.0	10	300	100(Ta)	0.4	10/10	0.18	10/20	15	0.4	
	3.5	Axial (φ6.5/φ1.4)	RU 4Z	70	-40~+150	1.3	3.5	10	300	100	0.4	10/10	0.18	10/20	8.0	1.2	
400	5.0	TO-220F (Center-tap)	FMU-12S, R	30	-40~+150	1.5	2.5	50	500	100(Ta)	0.4	100/100	0.18	100/200	4.0	2.1	
	10	TO-220F (Center-tap)	FMU-22S, R	40	-40~+150	1.5	5.0	50	3000	150	0.4	100/100	0.18	100/200	4.0	2.1	
	0.25	Axial (φ2.7/φ0.6)	EU01	15	-40~+150	2.5	0.25	10	150	100(Ta)	0.4	10/10	0.18	10/20	20	0.2	
	0.25	Axial (φ2.7/φ0.78)	EU 1	15	-40~+150	2.5	0.25	10	150	100(Ta)	0.4	10/10	0.18	10/20	17	0.3	
	0.25	Axial (φ4.0/φ0.78)	RU 1	15	-40~+150	2.5	0.25	10	200	100(Ta)	0.4	10/10	0.18	10/20	15	0.4	
	0.5	Axial (φ2.4/φ0.6)	AU01	15	-40~+150	1.7	0.5	10	150	100(Ta)	0.4	10/10	0.18	10/20	22	0.13	
	0.6	Axial (φ2.4/φ0.6)	AS01	20	-40~+150	1.5	0.6	10	50	100	1.5	10/10	0.6	10/20	22	0.13	
	0.6	Axial (φ2.7/φ0.78)	EH 1	30	-40~+150	1.35	0.6	10	200	100(Ta)	4.0	10/10	1.3	10/20	17	0.3	
	0.7	Axial (φ2.7/φ0.78)	ES 1	30	-40~+150	2.5	0.8	10	200	100(Ta)	1.5	10/10	0.6	10/20	20	0.2	
	0.8	Axial (φ2.4/φ0.6)	AU02	25	-40~+150	1.3	0.8	10	250	100	0.4	10/10	0.18	10/20	22	0.13	
600	1.0	Axial (φ2.7/φ0.6)	EU02	15	-40~+150	1.4	1.0	10	300	100	0.4	10/10	0.18	10/20	20	0.2	
	1.0	Axial (φ2.7/φ0.78)	EU 2	15	-40~+150	1.4	1.0	10	300	100	0.4	10/10	0.18	10/20	17	0.3	
	1.1	Axial (φ4.0/φ0.78)	RU 2M	20	-40~+150	1.2	1.1	10	300	100	0.4	10/10	0.18	10/20	15	0.4	
	1.5	Axial (φ4.0/φ0.98)	RU 3	20	-40~+150	1.5	1.5	10	400	100	0.4	10/10	0.18	10/20	12	0.6	
	1.5	Axial (φ4.0/φ0.98)	RU 3M	50	-40~+150	1.1	1.5	10	350	100	0.4	10/10	0.18	10/20	12	0.6	
	1.5(3.0)	Axial (φ6.5/φ1.4)	RU 4	50	-40~+150	1.5	3.0	10	300	100(Ta)	0.4	10/10	0.18	10/20	8.0	1.2	
	2.0(3.5)	Axial (φ6.5/φ1.4)	RU 4M	70	-40~+150	1.3	3.5	10	300	100	0.4	100/100	0.18	100/200	8.0	1.2	
	5.0	TO-220F (Center-tap)	FMU-14S, R	30	-40~+150	1.5	2.5	50	500	100(Ta)	0.4	100/100	0.18	100/200	4.0	2.1	
	10	TO-220F (Center-tap)	FMU-24S, R	40	-40~+150	1.5	5.0	50	3000	150	0.4	100/100	0.18	100/200	4.0	2.1	
	0.25	Axial (φ4.0/φ0.78)	RU 1A	15	-40~+150	2.5	0.25	10	150	100	0.4	10/10	0.18	10/20	15	0.4	
0.5	Axial (φ2.4/φ0.6)	AU01A	15	-40~+150	1.7	0.5	10	150	100(Ta)	0.4	10/10	0.18	10/20	22	0.13		
0.6	Axial (φ4.0/φ0.78)	RF 1A	15	-40~+150	2.0	0.6	10	200	100(Ta)	0.4	10/10	0.18	10/20	15	0.4		
0.6	Axial (φ2.4/φ0.6)	AS01A	20	-40~+150	1.5	0.6	10	50	100	1.5	10/10	0.6	10/20	22	0.13		
0.6	Axial (φ4.0/φ0.78)	RH 1A	35	-40~+150	1.3	0.6	5.0	70	150(Ta)	4.0	10/10	1.3	10/20	15	0.4		
0.7	Axial (φ2.7/φ0.6)	ES01A	20	-40~+150	3.0	0.8	10	200	100(Ta)	1.5	10/10	0.6	10/20	20	0.2		
0.7	Axial (φ4.0/φ0.78)	RS 1A	30	-40~+150	2.5	0.8	10	2000	150	1.5	10/10	0.6	10/20	15	0.4		
0.8	Axial (φ2.4/φ0.6)	AU02A	25	-40~+150	1.3	0.8	10	250	100(Ta)	0.4	10/10	0.18	10/20	22	0.13		
1.0	Axial (φ2.7/φ0.6)	EU02A	15	-40~+150	1.4	1.0	10	300	100	0.4	10/10	0.18	10/20	20	0.2		
1.0	Axial (φ2.7/φ0.78)	EU 2A	15	-40~+150	1.4	1.0	10	300	100(Ta)	0.4	10/10	0.18	10/20	17	0.3		
1.0	Axial (φ4.0/φ0.78)	RU 2	20	-40~+150	1.5	1.0	10	300	100(Ta)	0.4	10/10	0.18	10/20	15	0.4		
1.1	Axial (φ4.0/φ0.78)	RU 2AM	20	-40~+150	1.2	1.1	10	300	100	0.4	10/10	0.18	10/20	15	0.4		
1.5	Axial (φ4.0/φ0.98)	RU 3A	20	-40~+150	1.5	1.5	10	400	100	0.4	10/10	0.18	10/20	12	0.6		
1.5	Axial (φ4.0/φ0.78)	RU 20A	50	-40~+150	1.1	1.5	10	350	100	0.4	10/10	0.18	10/20	15	0.4		
1.5	Axial (φ4.0/φ0.98)	RU 3AM	50	-40~+150	1.1	1.5	10	350	100	0.4	10/10	0.18	10/20	12	0.6		
1.5(3.0)	Axial (φ6.5/φ1.4)	RU 4A	50	-40~+150	1.5	3.0	10	300	100(Ta)	0.4	10/10	0.18	10/20	8	1.2		
3.0	Axial (φ4.0/φ0.98)	RY 2A	50	-40~+150	1.15	3.0	10	1000	150	0.2	100/100	0.1	100/200	12	0.6		
3.0	TO-220F2Pin	FMU-1036S	50	-40~+150	1.15	3.0	10	1000	150	0.2	100/100	0.1	100/200	4.0	2.1		
5.0	TO-220F2Pin	FMU-G16S	30	-40~+150	1.25	5.0	50	500	100(Ta)	0.4	100/100	0.18	100/200	4.0	2.1		
5.0	TO-220F (Center-tap)	FMU-16S, R	30	-40~+150	1.5	2.5	50	500	100(Ta)	0.4	100/100	0.18	100/200	4.0	2.1		
10	TO-220F (Center-tap)	FMU-26S, R	40	-40~+150	1.5	5.0	50	3000	150	0.4	100/100	0.18	100/200	4.0	2.1		
10	TO-220F2Pin	FMU-G26S	40	-40~+150	1.35	10	50	500	150	0.4	100/100	0.18	100/200	4.0	2.1		
10	TO-220F2Pin	FMY-1106S	180	-40~+150	1.15	10	30	3000	150	0.2	100/100	0.1	100/200	4.0	2.1		
20	TO-220F (Center-tap)	FMY-2206S *	180	-40~+150	1.15	10	30	3000	150	0.2	100/100	0.1	100/200	4.0	2.1		

\* : 開発中

・No. 13 Axial ( $\phi 4.0 / \phi 0.78$ )

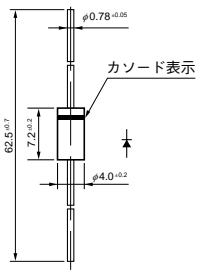

・No. 14 Axial ( $\phi 4.0 / \phi 0.98$ )

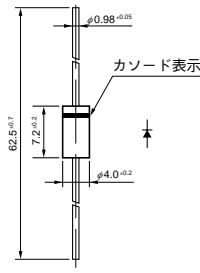

・No. 15 Axial ( $\phi 6.5 / \phi 1.4$ )

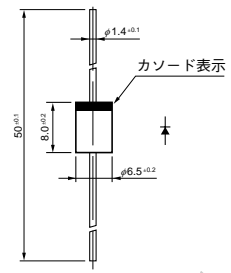

・No. 16 TO-220F (2素子)

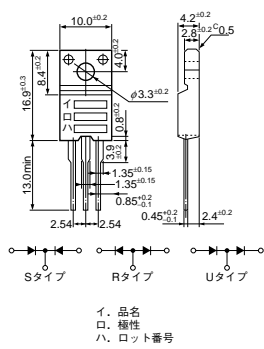

・No. 17 TO-220F (Center-tap)

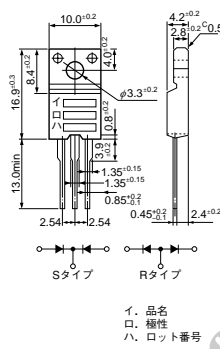

・No. 18 TO-220F2Pin

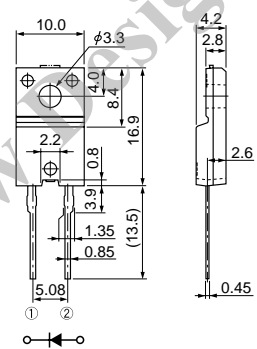

・No. 19 TO-220F2Pin (2素子)

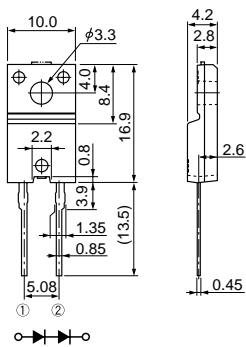

・No. 20 TO3PF

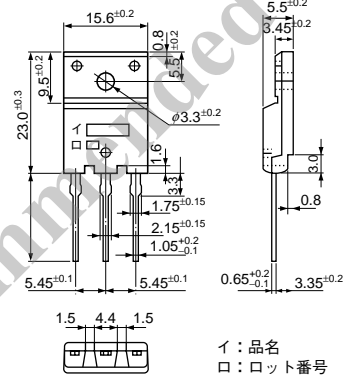

・No. 21 TO3PF2Pin

